

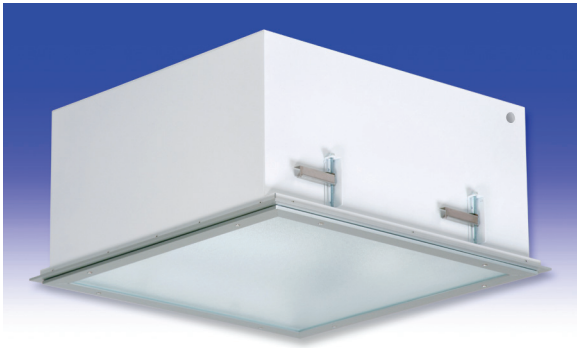

F8/V6 Series

HID | FLANGE 



2x2 HID APPLICATIONS:

- UL/CUL Listed Wet Location
- Cleanroom (Classes 100-100,000; ISO Classes 5-9)
- UL/CUL Hazardous Location (Class I, Division 2; Groups A, B, C & D; Class II, Division 2; Groups F & G)
- NSF Certified Food Processing (Splash Zone, Food Zone)
- Industrial & Commercial

BENEFITS:

- Luminaires adaptable to your specific needs

FEATURES:

- Available with **IP 65 rating**, add -IP65 suffix (requires stainless steel lens frame)
- Available in stainless steel construction
- Every luminaire tested with lamps to assure customer satisfaction
- 5 year limited warranty
- Proudly made in **USA**

SPECIFICATIONS:

HOUSING:

Constructed of nominal 20GA (.036) zinc coated steel for unmatched corrosion protection. One welded, tapered, threaded flange on the side provides a sealed wireway access. All seams are sealed with a long life acrylic sealant.

REFLECTOR:

Fabricated of diffuse aluminum.

LENS FRAME:

Exclusively designed, heavy duty, extruded, anodized aluminum with stainless steel captive screws used to hold the lens frame tight to the housing. The frame is hinged for support while servicing.

Food Zone: Lens frame and trim frame of stainless steel (S6 option std).

GASKETING:

Silicone sealant is used to seal the lens into the frame; with our exclusive, mechanically held, extruded, silicone gasket used to seal the frame to the housing.

Food Zone: Adhesive sealant is used to seal the lens into the stainless steel frame, with EPDM sealing the frame to the housing.

FINISH:

Painted surfaces are two mil of white polyester enamel.

LENS:

.187 pattern 62 tempered glass.

Splash and Food Zones:

.187 pattern 62 tempered glass with .080 clear polycarbonate overlay.

ELECTRICAL:

Core and coil ballast standard. Porcelain mogul base lampholder has a nickel plated screw shell.

MOUNTING:

Flange or custom detail available.

TEMPERATURE:

Class I, Div. 2 - T1 (340°C); Class II, Div. 2 - T3B (165°C).

F8: Horizontal Lamp Position

HAZ. LOCATION: 1/2" THREADED HUB (WIRE ENTRY)

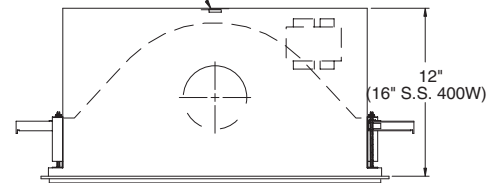

V6: Vertical Lamp Position

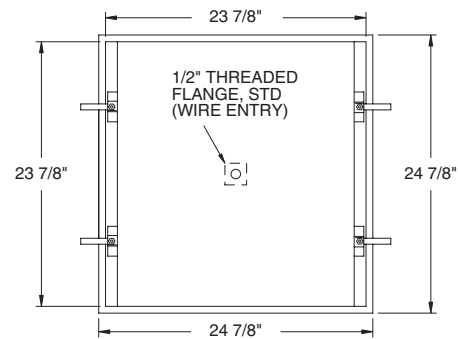
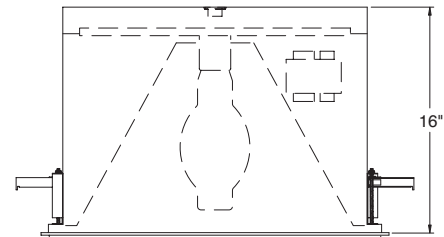

CEILING CUT-OUT DIMENSIONS: 24 1/8" x 24 1/8"

LENS FRAME DETAILS:

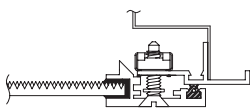

ALUMINUM
LENS FRAME DETAIL

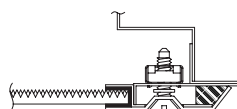

STAINLESS STEEL
LENS FRAME DETAIL

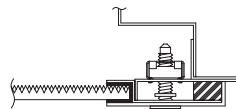

HAZ. LOC. STAINLESS STEEL
LENS FRAME DETAIL

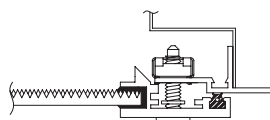

SPLASH ZONE
LENS FRAME DETAIL

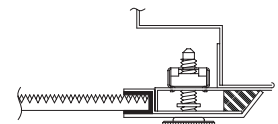

FOOD ZONE
LENS FRAME DETAIL



Hazardous Location:



Food Processing:



F8/V6 Series

**PHOTOMETRICS:** For additional photometry, go to paramountlighting.com

Model F8400M9, Semi-diffuse Reflector and Tempered Glass Lens, 400W BT-37 MH Lamp, Lamp Lumen Rating = 40000

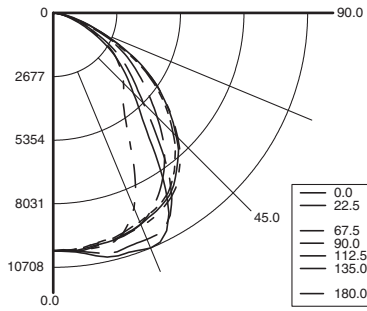
**Coefficients of Utilization, Zonal Cavity Method**

Floor Cavity Reflectance: 20%

RC	.8			.7			.5			.3			.1			0		
RW	.7	.5	.3	.1	.7	.5	.3	.1	.5	.3	.1	.5	.3	.1	.5	.3	.1	0
R 0	76	76	76	76	74	74	74	74	70	70	70	67	67	67	65	65	65	63
C 1	70	67	65	63	68	66	64	62	63	61	60	61	59	58	58	57	56	55
R 2	64	59	55	52	62	58	55	52	56	53	50	54	51	49	52	50	48	47
3	59	53	48	44	57	52	47	44	50	46	43	48	45	42	46	44	41	40
4	54	47	42	38	53	46	41	37	45	40	37	43	39	36	42	39	36	35
5	50	42	37	33	49	41	36	33	40	36	32	39	35	32	38	34	31	30
6	46	38	33	29	45	37	32	29	36	32	28	35	31	28	34	31	28	27
7	43	35	29	25	42	34	29	25	33	28	25	32	28	25	31	28	25	24
8	40	32	26	23	39	31	26	23	30	26	23	29	25	22	29	25	22	21
9	37	29	24	20	36	29	24	20	28	23	20	27	23	20	27	23	20	19
10	35	27	22	19	34	26	22	19	26	21	18	25	21	18	25	21	18	17

Zonal Lumen Summary

Zone	Lumens	% Lamp	% Luminaire
0-30	8168	20.4	32
0-40	13228	33.1	51.9
0-60	21942	54.9	86
0-90	25502	63.8	100
90-120	0	0	0
90-130	0	0	0
90-150	0	0	0
90-180	0	0	0
0-180	25502	63.8	100

Total Luminaire Optical Efficiency = 63.8%

Spacing Criterion: 0° = 1.30, 90° = 1.35

2x2 HID FLANGE LUMINAIRE ORDERING INFORMATION:

SERIES	LAMP WATTS	LAMP TYPE	9	OPT MAT	OPTIONS	VOLTAGE
Horizontal Lamp F8 Wet Location HF8 Hazardous SF8 Splash Zone FF8 Food Zone Vertical Lamp V6 Wet Location SV6 Splash Zone FV6 Food Zone	150* 175* MH only 200 MH only 250* 320 MH only 350* MH only 400*	M MH Magul Base S HPS Magul Base	9 .187 Tempered Glass (P62) FOOD ZONE ONLY 9 .187 Tempered Glass (P62) with .080 Clear Polycarbonate Overlay		FUSING F2 GMF/HLR Fusing (Slow) LENSING H5 .156 C73 Tempered Glass H6 .187 Clear Tempered Glass J2 .060 Clear Acrylic Overlay (N/A Food Zone) J6 .080 Clear Polycarbonate Overlay (Std, Food Zone) J8 Wire Guard (N/A Splash Zone/Food Zone) K0 .200 V825 Acrylic (N/A Food Zone) K6 External Prisms (N/A Splash Zone/Food Zone) MISC IP65 IP rated (-S5 option required) P1 Zinc Coated Steel Plaster Frame P3 Stainless Steel Plaster Frame P9 Special Paint Color (Provide Paint Code & Chip) R4 Asymmetric Reflector (N/A Vertical Lamp) S1 Special Material (Consult Agent) T3 Tamper Resistant (Hex w/pin STD, Others Avail) V1 External Gasketing (N/A Splash Zone/Food Zone) Y3 Quartz Restrike (N/A Hazardous Location)	120V-277V/60Hz STD 208V/60Hz 240V/60Hz 347V/60Hz 480V/60Hz 50Hz Available

* Lamp Type Available for Hazardous Location.

*S2 Stainless Steel Housing

*S3 Stainless Steel Exterior

*S5 Stainless Steel Lens Frame Only

*S6 SS Lens Frame & Trim Frame

* Note:

If Stainless Steel is ordered,

304 SS Standard

316 SS and other materials

available, consult agent.

Add hyphens between options

F8 Series requires 16" deep housing when Stainless Steel.**All Vertical Lamp models require 16" deep housing.****Other Wattages Available, Consult Factory.****NSF Food Processing Note:**

Food Zone (F prefix) luminaires come in DIRECT CONTACT with food.

Splash Zone (S prefix) units may become soiled, but are outside the danger of recontamination.

Information subject to change without notice. Lamps supplied by others.

© 2010 Paramount Industries, Inc. P.O. Box 259 Crosswell, MI 48422

Project Information: